



Technical Data and Specifications  
for

# XR<sup>®</sup> Geomembranes

XR-3<sup>®</sup>  
XR-5<sup>®</sup>  
XR-3<sup>®</sup> PW

Industrial, Municipal and Potable Water  
Grade Geomembranes



**Seaman Corporation**

1000 Venture Blvd.  
Wooster, Ohio 44691  
(330) 262-1111  
[www.xr-5.com](http://www.xr-5.com)

**Section 1: Product Overview/Applications**

Product Application Chart

**Section 2: Physical Properties**

Part 1: Material Specifications

8130/8138 XR-5

6730 XR-5

8228 XR-3

8130 XR-3 PW

Part 2: Elongation Properties

8130/8138 XR-5

6730 XR-5

8228 XR-3

**Section 3: Chemical/Environmental Resistance**

Part 1: Chemical Resistance

XR-5 Chemical Resistance

Chemical Resistance Chart

Vapor Transmission Data

Seam Strength

Long Term Seam Adhesion

Fuel Compatibility

XR-3 Chemical Resistance Statement (Summary)

Part 2: Comparative Chemical Resistance (XR-5)

Part 3: Weathering Resistance

**Section 4: Comparative Physical Properties**

XR-5/HDPE Physicals - Comparative Properties

XR-5/Polypropylene Tensile

Puncture Strength Comparison

Coated Fabric Thermal Stability

**Section 5: Sample Specifications**

**Section 6: Warranty Information**

# Seaman Corp. XR Geomembranes

## Section 1 - Product Overview/Applications

- All XR Geomembrane products are classified as an Ethylene Interpolymer Alloy (EIA)
- XR-5 grade is high strength and chemically resistant for maximum resistance to high temperature, and broad chemical resistance, including acids, oils and methane
- XR-3 grade for moderate chemical resistant requirement applications such as stormwater and domestic wastewater
- NSF 61 approved XR-3 PW grade for potable water contact
- Heat weldable-thermal weldable for seams as strong as the membrane. Factory panels over 15,000 square feet (1400 sq meters) for less field seaming
- Stability is excellent, with low thermal expansion-contraction properties
- 30+ year application history

### Product Application Chart

	XR-5			XR-3	XR-3 PW
	8130	8138	6730	8228	8130
High Puncture Resistance	X	X	X		X
UV Resistance	X	X	X	X	X
High Strength Applications	X	X	X		X
Floating Covers (Nonpotable)	X	X	X	X	
Diesel/Jet Fuel Containment	X	X	X		
Industrial Wastewater	X	X	X		
Stormwater	X	X	X	X	
Municipal/Domestic Wastewater	X	X	X	X	
Floating Diversion Baffles/Curtains	X		X		X
Potable Water					X
<-65 Deg F Applications	Contact Seaman Corp.				
Chemically Resistant Applications	X	X	X		

XR-5® is a registered trademark of Seaman Corporation  
 XR-3® is a registered trademark of Seaman Corporation  
 XR® is a registered trademark of Seaman Corporation

## Section 2 - Physical Properties

### Part 1- Material Specifications

Property	Test Method	8130 XR-5	8138 XR-5	6730 XR-5
Base Fabric Type Base Fabric Weight	ASTM D 751	Polyester 6.5 oz/yd <sup>2</sup> nominal (220 g/m <sup>2</sup> nominal)	Polyester 6.5 oz/yd <sup>2</sup> nominal (220 g/m <sup>2</sup> nominal)	Polyester 7 oz/yd <sup>2</sup> nominal (235 g/m <sup>2</sup> nominal)
Thickness	ASTM D 751	30 mils min. (0.76 mm min.)	40 mils nom. (1.0 mm nom.)	30 mils min. (0.76 mm min.)
Weight	ASTM D 751	30.0 +- 2 oz/sq yd (1017 +- 2 g/m <sup>2</sup> )	38.0 +- 2 oz/sq yd (1288 +- 70 g/m <sup>2</sup> )	30.0 +- 2 oz/sq yd (1017 +- 70 g/m <sup>2</sup> )
Tear Strength	ASTM D 751 Trap Tear	40/55 lbs. min. (175/245 N min.)	40/55 lbs. min. (175/245 N min.)	
Breaking Yield Strength	ASTM D 751 Grab Tensile	550/550 lbs. min. (2,447/2,447 N min.)	550/550 lbs. min. (2,447/2,447 N min.)	600/550 lbs. min. (2,670/2,447 N min.)
Low Temperature Resistance	ASTM D 2136 4 hrs-1/8" Mandrel	Pass @ -30° F Pass @ -35° C	Pass @ -30° F Pass @ -35° C	Pass @ -30° F Pass @ -35° C
Dimensional Stability	ASTM D 1204 100° C-1 Hr.	0.5% max. each direction	0.5% max. each direction	0.5% max. each direction
Hydrostatic Resistance	ASTM D 751 Procedure A	800 psi min. (5.51 MPa min.)	800 psi min. (5.51 MPa min.)	800 psi min. (5.51 MPa min.)
Blocking Resistance	ASTM D 751 180° F	#2 Rating max.	#2 Rating max.	#2 Rating max.
Adhesion-Ply	ASTM D 413 Type A	15 lbs./in. min. or film tearing bond (13 daN/5 cm min. or FTB)	15 lbs./in. min. or film tearing bond (13 daN/5 cm min. or FTB)	15 lbs./in. min. or film tearing bond (13 daN/5 cm min. or FTB)
Adhesion (minimum) Heat Welded Seam	ASTM D 751 Dielectric Weld	40 lbs./2in. RF weld min. (17.5 daN/5 cm min.)	40 lbs./2in. RF weld min. (17.5 daN/5 cm min.)	15 lbs./in. RF weld min. (15 daN/5 cm min.)
Dead Load Seam Strength	ASTM D 751, 4-Hour Test	Pass 220 lbs/in @ 70° F (Pass 980 N/2.54 cm @ 21° C) Pass 120 lbs/in @ 160° F (Pass 534 N/2.54 cm @ 70° C)	Pass 220 lbs/in @ 70° F (Pass 980 N/2.54 cm @ 21° C) Pass 120 lbs/in @ 160° F (Pass 534 N/2.54 cm @ 70° C)	
Bonded Seam Strength	ASTM D 751 Procedure A, Grab Test Method	550 lbs. min. (2,450 N min.)	550 lbs. min. (2,450 N min.)	550 lbs. min. (2,560 N min.)

Abrasion Resistance	ASTM D 3389 H-18 Wheel 1 kg Load	2,000 cycles min. before fabric exposure, 50 mg/100 cycles max. weight loss	2,000 cycles min. before fabric exposure, 50 mg/100 cycles max. weight loss	2,000 cycles min. before fabric exposure, 50 mg/100 cycles max. weight loss
Weathering Resistance	Carbon-Arc ASTM G 153	8,000 hours min. with no appreciable changes or stiffening or cracking of coating	8000 hours min. with no appreciable change or stiffening or cracking of coating	8000 hours min. with no appreciable change or stiffening or cracking of coating
Water Absorption	ASTM D 471, Section 12 7 Days	0.025 kg/m <sup>2</sup> max. @70° F/21° C 0.14 kg/m <sup>2</sup> max at 212° F/100° C	0.025 kg/m <sup>2</sup> max. @70° F/21° C 0.14 kg/m <sup>2</sup> max at 212° F/100° C	0.025 kg/m <sup>2</sup> max. @70° F/21° C 0.14 kg/m <sup>2</sup> max at 212° F/100° C
Wicking	ASTM D 751	1/8" max (0.3 cm max)	1/8" max. (0.3 cm max.)	1/8" max. (0.3 cm max.)
Bursting Strength	ASTM D 751 Ball Tip	750 lbs. min. (3,330 N min.)	750 lbs. min. (3,330 N min.)	750 lbs. min. (3,330 N min.)
Puncture Resistance	ASTM D 4833	275 lbs. min. 1,200 N min.	275 lbs. min. 1,200 N min.	275 lbs. min. 1,200 N min.
Coefficient of Thermal Expansion/Contraction	ASTM D 696	8 x 10 <sup>-6</sup> in/in/° F max. (1.4 x 10 <sup>-5</sup> cm/cm/° C max.)	8 x 10 <sup>-6</sup> in/in/° F max. (1.4 x 10 <sup>-5</sup> cm/cm/° C max.)	8 x 10 <sup>-6</sup> in/in/° F max. (1.4 x 10 <sup>-5</sup> cm/cm/° C max.)
Environmental/Chemical Resistant Properties		See Chemical Resistance Table, Page 8	See Chemical Resistance Table, Page 8	See Chemical Resistance Table, Page 8
Puncture Resistance	FED-STD-101C Method 2031	350 lbs. (approx.)	350 lbs. (approx.)	
Cold Crack	ASTM D 2136 4 Hrs, 1/8" Mandrel	Pass at -30° F/-34° C	Pass @ -30° F/-34° C	Pass @ -30° F/-34° C

## Section 2 - Physical Properties

### Part 1- Material Specifications (cont.)

Property	Test Method	8130 XR-3 PW	8228 XR-3
Base Fabric Type Base Fabric Weight	ASTM D 751	Polyester 6.5 oz/yd <sup>2</sup> nominal (220 g/m <sup>2</sup> nominal)	Polyester 3.0 oz/yd <sup>2</sup> nominal (100 g/m <sup>2</sup> nominal)
Thickness	ASTM D 751	30 mils min. (0.76 mm min.)	30 mils min. (0.76 mm min.)
Weight	ASTM D 751	30.0 +- 2 oz./sq. yd. (1017 +- 70 g/sq. m)	28.0 +- 2 oz./sq. yd. (950 +- 70 g/sq. m)
Tear Strength	ASTM D 751 Trap Tear	40/55 lbs. min. (175/245 N min.)	30/30 lbs. nom. (133/133 N nom.)
Breaking Yield Strength	ASTM D 751 Grab Tensile	550/550 lbs. min. (2,447/2447 N min.)	250/200 lbs. min. (1,110/890 N min.)
Low Temperature Resistance	ASTM D 2136 4hrs-1/8" Mandrel	Pass @ -30° F (Pass @ -35° C)	Pass @ -25° F (Pass @ -32° C)
Dimensional Stability	ASTM D 1204 100° C-1 hr.	0.5% max. each direction	5% max. each direction
Hydrostatic Resistance	ASTM D 751 Method A	800 psi min. (5.51 MPa min.)	300 psi min. (2.07 MPa min.)
Blocking Resistance	ASTM D 751 180° F	#2 Rating max.	#2 Rating max.
Adhesion-Ply	ASTM D 413 Type A	15 lbs./in. min. or film tearing bond (13 daN/5 cm min. or FTB)	12 lbs./in. (approx.) (10 daN/5 cm approx.)
Adhesion- Heat Welded Seam	ASTM D 751 Dielectrc Weld	40 lbs./2in. min. (17.5 daN/5 cm min.)	10 lbs./in min. (9 daN/5 cm min.)
Dead Load Seam Strength	ASTM D 751, 4-Hour Test	Pass 220 lbs/in. @ 70° F (Pass 980 N/2.54 cm @ 21° C) Pass 120 lbs/in. @ 160° F (Pass 534 N/2.54 cm @ 70° C)	Pass 100 lbs/in @ 70° F (Pass 445 N @ 21° C) Pass 50 lb @ 160° F (Pass 220 N @ 70° C)
Bonded Seam Strength	ASTM D 751 Procedure A, Grab Test Method	550 lbs. min. (2,450 N min.)	250 lbs. (approx.) (1,112 N min.)

Abrasion Resistance	ASTM D 3389 H-18 Wheel 1 kg Load	2000 cycles min. before fabric exposure, 50 mg/100 cycles max. weight loss	2000 cycles min.
Weathering Resistance	ASTM G 153	8000 hours min. with no appreciable change or stiffening or cracking of coating	8000 hours min.
Water Absorption	ASTM D 471, Section 12 7 Days	0.025 kg/m <sup>2</sup> max. @ 70° F/21° C 0.14 kg/m <sup>2</sup> max @ 212° F/100° C	0.05 kg/m <sup>2</sup> max. @ 70° F/21° C (approx.) 0.28 kg/m <sup>2</sup> max. @ 212° F/100° C (approx.)
Wicking	ASTM D 751	1/8" max. (0.3 cm max.)	1/8" max (0.3 cm max.)
Bursting Strength	ASTM D 751 Ball Tip	750 lbs. min. (3330 N min.)	350 lbs. (approx.) (1557 N min.)
Puncture Resistance	ASTM D 4833	275 lbs. min. 1200 N min.	50 lb typ. (225 N typ.)
Coefficient of Thermal Expansion/Contraction	ASTM D 696	8 x 10 <sup>-6</sup> in/in/° F max. (1.4 x 10 <sup>-5</sup> cm/cm/° C max.)	8 x 10 <sup>-6</sup> in/in/° F max. (approx.) (1.4 x 10 <sup>-5</sup> cm/cm/° C max. approx.)
Environmental/Chemical Resistant Properties	ASTM D 741 7-Day Total Immersion With Exposed Edges	NSF 61 approved for potable water	Crude oil 5% max. weight gain Diesel fuel 5% max. weight gain
Puncture Resistance	FTMS 101C Method 2031	350 lbs. (approx.)	205 lbs. (approx.)
Tongue Tear	ASTM D 751		50 lbs. (approx.)

## Part 2 - Elongation Properties Test

### 8130 XR-5

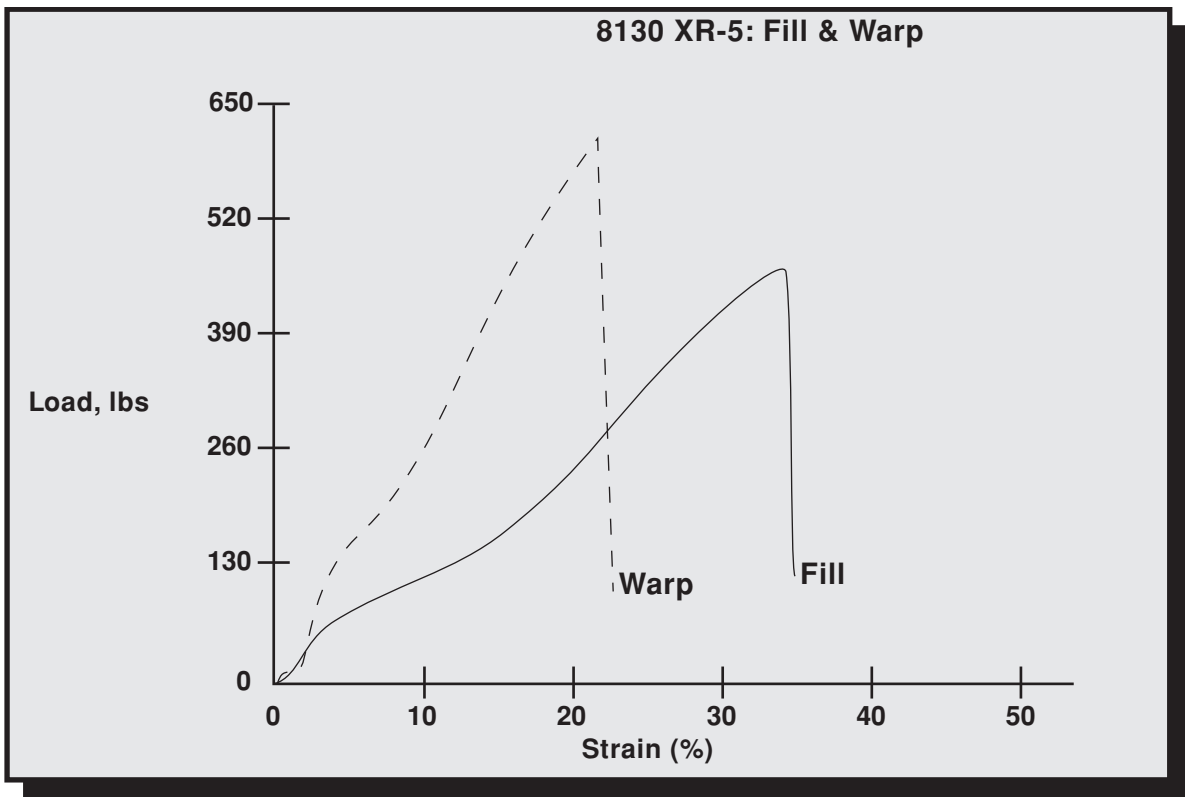



## Part 2 - Elongation Properties Test

### 6730 XR-5

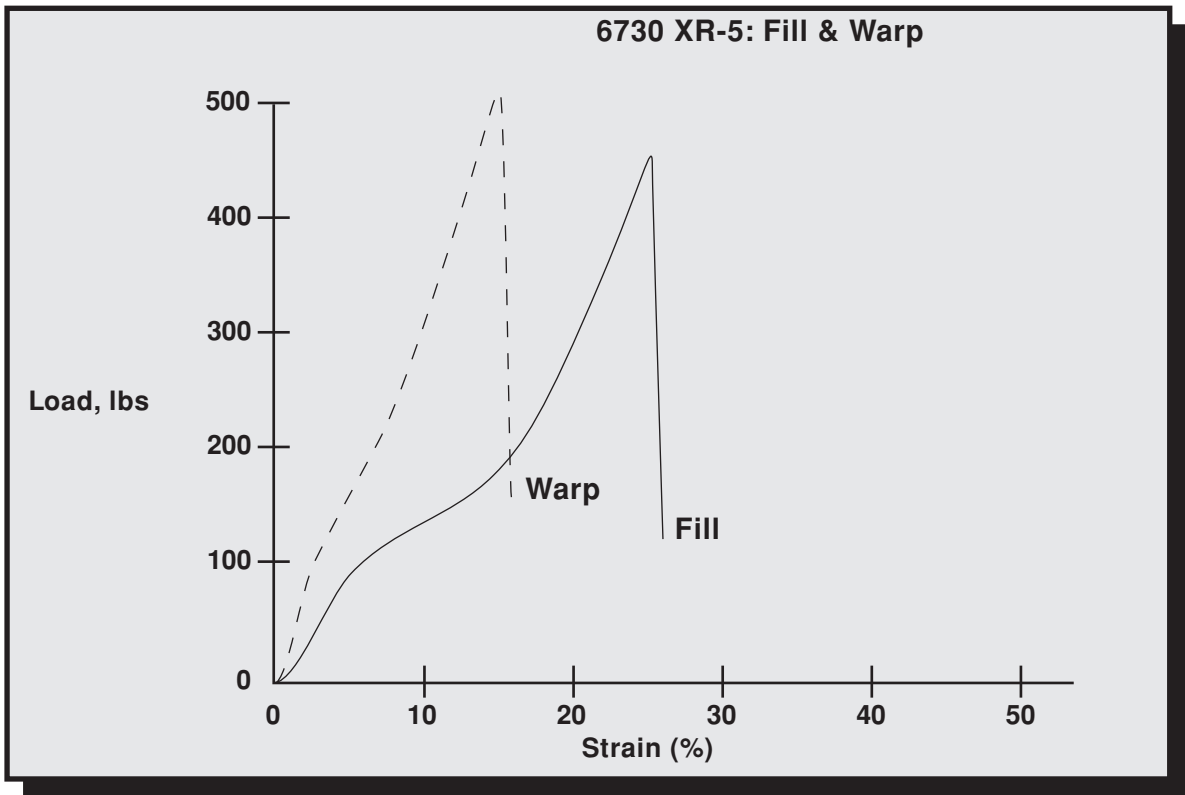

## Part 2 - Elongation Properties Test

### 8228 XR-3

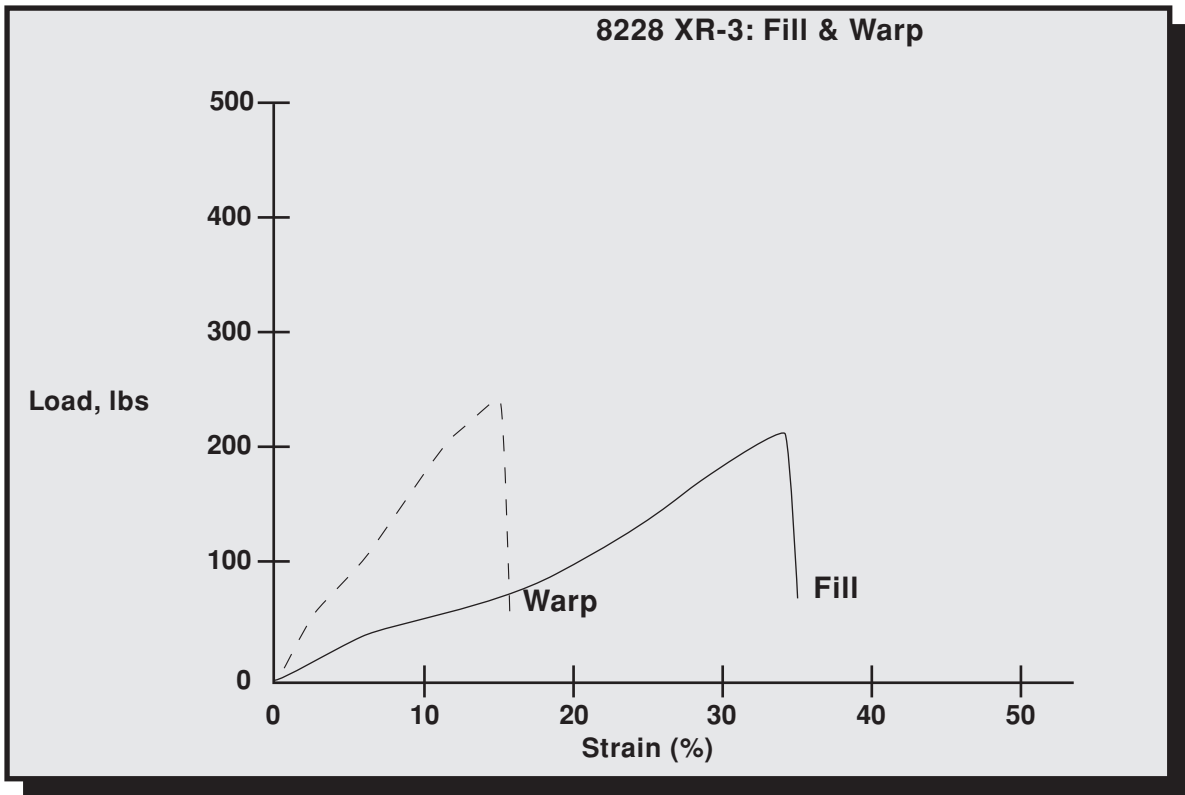

## Section 3 - Chemical/Environmental Resistance

### Part 1 - XR-5® Fluid Resistance Guidelines

The data below is the result of laboratory tests and is intended to serve only as a guide. No performance warranty is intended or implied. The degree of chemical attack on any material is governed by the conditions under which it is exposed. Exposure time, temperature, and size of the area of exposure usually varies considerably in application, therefore, this table is given and accepted at the user's risk. Confirmation of the validity and suitability in specific cases should be obtained. Contact a Seaman Corporation Representative for recommendation on specific applications.

When considering XR-5 for specific applications, it is suggested that a sample be tested in actual service before specification. Where impractical, tests should be devised which simulate actual service conditions as closely as possible.

EXPOSURE	RATING	EXPOSURE	RATING
AFFF	A	JP-4 Jet Fuel	A
Acetic Acid (5%)	B	JP-5 Jet Fuel	A
Acetic Acid (50%)	C	JP-8 Jet Fuel	A
Ammonium Phosphate	T	Kerosene	A
Ammonium Sulfate	T	Magnesium Chloride	T
Antifreeze (Ethylene Glycol)	A	Magnesium Hydroxide	T
Animal Oil	A	Methanol	A
Aqua Regia	X	Methyl Alcohol	A
ASTM Fuel A (100% Iso-Octane)	A	Methyl Ethyl Ketone	X
ASTM Oil #2 (Flash Pt. 240° C)	A	Mineral Spirits	A
ASTM Oil #3	A	Naphtha	A
Benzene	X	Nitric Acid (5%)	B
Calcium Chloride Solutions	T	Nitric Acid (50%)	C
Calcium Hydroxide	T	Perchloroethylene	C
20% Chlorine Solution	A	Phenol	X
Clorox	A	Phenol Formaldehyde	B
Conc. Ammonium Hydroxide	A	Phosphoric Acid (50%)	A
Corn Oil	A	Phosphoric Acid (100%)	C
Crude Oil	A	Phthalate Plasticizer	C
Diesel Fuel	A	Potassium Chloride	T
Ethanol	A	Potassium Sulphate	T
Ethyl Acetate	C	Raw Linseed Oil	A
Ethyl Alcohol	A	SAE-30 Oil	A
Fertilizer Solution	A	Salt Water (25%)	B
#2 Fuel Oil	A	Sea Water	A
#6 Fuel Oil	A	Sodium Acetate Solution	T
Furfural	X	Sodium Bisulfite Solution	T
Gasoline	B	Sodium Hydroxide (60%)	A
Glycerin	A	Sodium Phosphate	T
Hydraulic Fluid- Petroleum Based	A	Sulphuric Acid (50%)	A
Hydraulic Fluid- Phosphate Ester Based	C	Tanic Acid (50%)	A
Hydrocarbon Type II (40% Aromatic)	C	Toluene	C
Hydrochloric Acid (50%)	A	Transformer Oil	A
Hydrofluoric Acid (5%)	A	Turpentine	A
Hydrofluoric Acid (50%)	A	Urea Formaldehyde	A
Hydrofluosilicic Acid (30%)	A	UAN	A
Isopropyl Alcohol	T	Vegetable Oil	A
Ivory Soap	A	Water (200°F)	A
Jet A	A	Xylene	X
		Zinc Chloride	T

Ratings are based on visual and physical examination of samples after removal from the test chemical after the samples of Black XR-5 were immersed for 28 days at room temperature. Results represent ability of material to retain its performance properties when in contact with the indicated chemical.

#### Rating Key:

- A – Fluid has little or no effect
- B – Fluid has minor to moderate effect
- C – Fluid has severe effect
- T – No data - likely to be acceptable
- X – No data - not likely to be acceptable

## Vapor Transmission Data

### Tested according to ASTM D814-55 Inverted Cup Method

Perhaps a more meaningful test is determination of the diffusion rate of the liquid through the membrane. The vapor transmission rate of Style 8130 XR-5® to various chemicals was determined by the ASTM D814-55 inverted cup method. All tests were run at room temperature and results are shown in the table.

Chemical	8130 XR-5 Black g/hr/m <sup>2</sup>
Water	0.11
#2 Diesel Fuel	0.03
Jet A	0.11
Kerosene	0.15
Hi-Test Gas	1.78
Ohio Crude Oil	0.03
Low-Test Gas	5.25
Raw Linseed Oil	0.01
Ethyl Alcohol	0.23
Naphtha	0.33
Perchloroethylene	38.58
Hydraulic Fluid	0.006
100% Phosphoric Acid	7.78
50% Phosphoric Acid	0.43
Ethanol (E-96)	0.65
Transformer Oil	0.005
Isopropyl Alcohol	0.44
JP4 (E-96)	0.81
JP8 (E-96)	0.42
Fuel B (E-96)	6.28
Fuel C (E-96)	7.87

Note: The tabulated values are measured Vapor Transmission Rates (VTR). Normal soil testing methods to determine permeability are impractical for synthetic membranes. An "equivalent hydraulic" permeability coefficient can be calculated but is not a direct units conversion. Contact Seaman Corporation for additional technical information.

## Seam Strength

### Style 8130 XR-5 Black Seam Strength After Immersion

Two pieces of Style 8130 were heat sealed together (seam width 1 inch overlap) and formed into a bag. Various oils and chemicals were placed in the bags so that the seam area was entirely covered. After 28 days at room temperature, the chemicals were removed and one inch strips were cut across the seam and the breaking strength immediately determined. Results are listed below.

Chemical	Seam Strength
None	340 Lbs. Fabric Break- No Seam Failure
Kerosene	355 Lbs. Fabric Break- No Seam Failure
Ohio Crude Oil	320 Lbs. Fabric Break- No Seam Failure
Hydraulic Fluid- Petroleum Based	385 Lbs. Fabric Break- No Seam Failure
Toluene	0 Lbs. Adhesion Failure
Naphtha	380 Lbs. Fabric Break- No Seam Failure
Perchloroethylene	390 Lbs. Fabric Break- No Seam Failure

Even though 1-inch overlap seams are used in the tests to study the accelerated effects, it is recommended that XR-5 be used with a 2-inch nominal overlap seam in actual application. In some cases where temperatures exceed 160°F and the application demands extremely high seam load, it may be necessary to use a wider width seam.

## Long Term Seam Adhesion

### 11 Years Immersion

#### ASTM D 751

#### Lbs./In.

Seam samples of 8130 XR-5® were dielectrically welded together and totally immersed in the liquids for 11 years. The samples were taken out, dried for 24 hours and visually observed for any signs of swelling, cracking, stiffening or degradation of the coating. The coating showed no appreciable degradation and no stiffening, swelling, cracking or peeling.

The adhesion, or resistance to separation of the coating from the base cloth, was then measured by ASTM D 751. Results show 8130 XR-5 maintains seam strength over this long period (11 years).

	Control	Crude Oil	JP-4 Jet Fuel	Diesel Fuel	Kerosene	Naphtha
8130 XR-5	20+	18	33	25	40	33*

Values in lbs./in.

\*The naphtha sample was sticky.

**We believe this information is the best currently available on the subject. We offer it as a suggestion in any appropriate experimentation you may care to undertake. It is subject to revision as additional knowledge and experience are gained. We make no guarantee of results and assume no obligation or liability whatsoever in connection with this information.**

## Fuel Compatibility - Long Term Immersion

**Test:** Samples of 8130 XR-5® Black were immersed in Diesel Fuel, JP-4 Jet Fuel, Crude Oil, Kerosene, and Naphtha for 6 1/2 years.

The samples were then taken out of the test chemicals, blotted and dried for 24 hours. The samples were observed for blistering, swelling, stiffening, cracking or delamination of the coating from the fiber.

**Results:** It was found in all cases that the 8130 XR-5, after immersion for six years, maintained its strength and there was no evidence of blistering, swelling, stiffening, cracking or delamination.

The strip tensile strength, or breaking strength, of the samples was measured after six years of immersion and the following are the results.

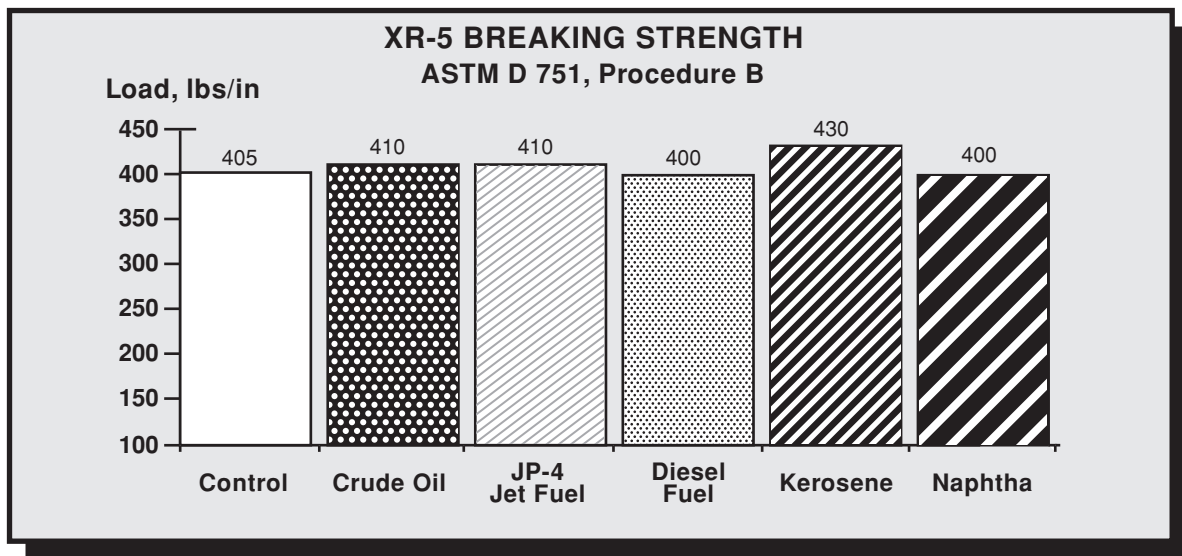

## XR-3 Chemical Resistance Statement (Summary)

XR-3® is recommended for moderate chemical resistant applications such as stormwater and municipal wastewater and is not recommended for prolonged contact with pure solutions. XR-3 PW® membranes are recommended only for contact with drinking water and are resistant to low levels of chlorine found in drinking water. XR-5 has a broad range of chemical resistance which is detailed in this section.

## Part 2: XR-5® Comparative Chemical Resistance

# Chemical Resistance Chart

## Comparative Chemical Resistance

	<u>XR-5</u>	<u>HDPE</u>	<u>PVC</u>	<u>Hypalon</u>	<u>Polypropylene</u>
Kerosene	A	B	C	C	C
Diesel Fuel	A	A	C	C	C
Acids (General)	A	A	A	B	A
Naphtha	A	A	C	B	C
Jet Fuels	A	A	C	B	C
Saltwater, 160° F	A	A	C	B	A
Crude Oil	A	B	C	B	C
Gasoline	B	B	C	C	C

**A= Excellent    B= Moderate    C= Poor**

Source: Manufacturer's Literature

XR-5 data based on conditions detailed in Section 3, Part 1.

## Part 3: Weathering Resistance

### Accelerated Weathering Test

XR-5 has been tested in the carbon arc weatherometer for over 10,000 hours of exposure and in the Xenon weatherometer for over 12,000 hours of exposure. The sample showed no loss in flexibility and no significant color change. Based on field experience of Seaman Corporation products and similar weatherometer exposure tests, XR-5 should have an outdoor weathering life significantly longer than competitive geomembranes, particularly in tropical or subtropical applications.

EMMAQUA Testing: ASTM E-838-81 was performed on a modified form of XR-5, FiberTite, used in the single-ply roofing industry. After 3 million Langleys in Arizona, no signs of degradation were noted with no evidence of cracking, blistering, swelling or adhesion delamination failure of the coating.

### Natural Exposure

After over 17 years as a holding basin at a large oil company in the Texas desert, XR-5 showed no signs of environmental stress cracking, thermal expansion/contraction, or low yield strength problems. Temperature ranges from near zero to over 100° F.

In service approximately 17 years in a solar pond application at a research facility in Ohio, UV exposed samples, as well as immersed samples, retained over 90% of the tensile strength. Examination of the material determined there was little effect on the coating compound. The solar pond was exposed to temperatures from below zero to over 100° F.

XR5 was exposed for 12½ years in Sarasota, Florida, on a weathering rack, facing the southern direction at 45°. No significant color loss, cracking, crazing, blistering, or adhesion delamination failure of the coating was noted.

## Section 4 - Comparative Physical Properties

### XR-5/HDPE Comparative Properties

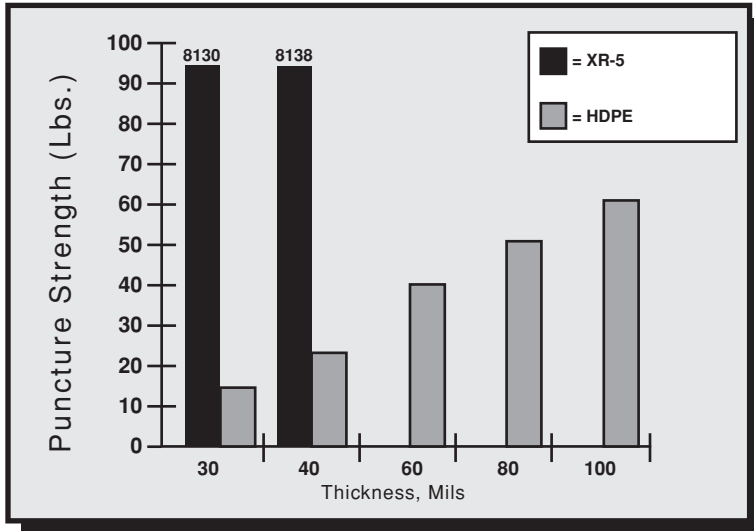

### Puncture Resistance

1. ASTM D 751, Screwdriver Tip, 45° Angle (Room Temperature) Puncture Resistance, XR5 vs. HDPE

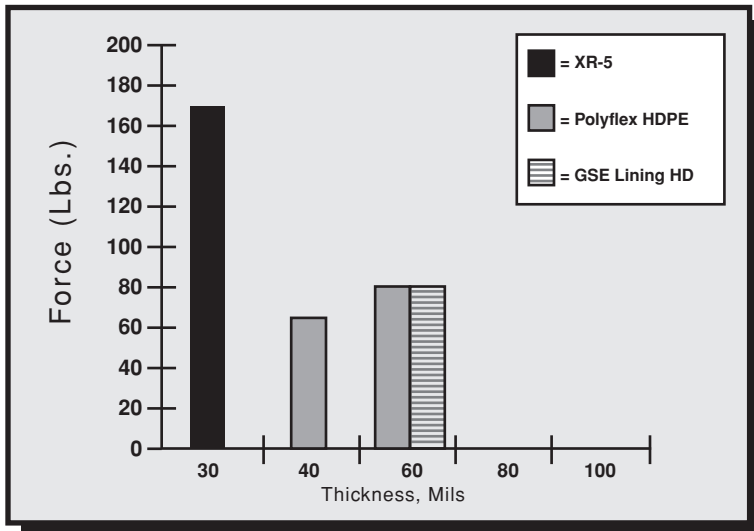

2. FED-STD-101C Method 2065 (Room Temperature)\*

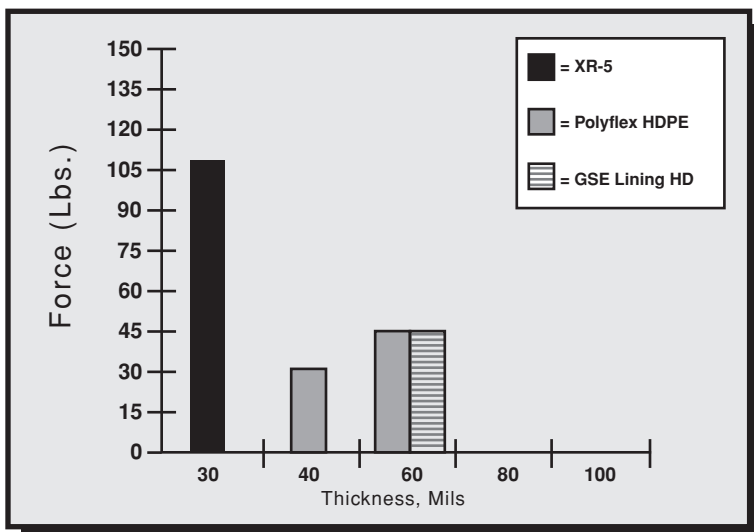

3. FED-STD-101C Method 2065 (70°C)\*

\* Data provided by E.I. DuPont de Nemours & Co. Wilmington, Delaware

GSE is a registered trademark of GSE Lining Technology, Inc.



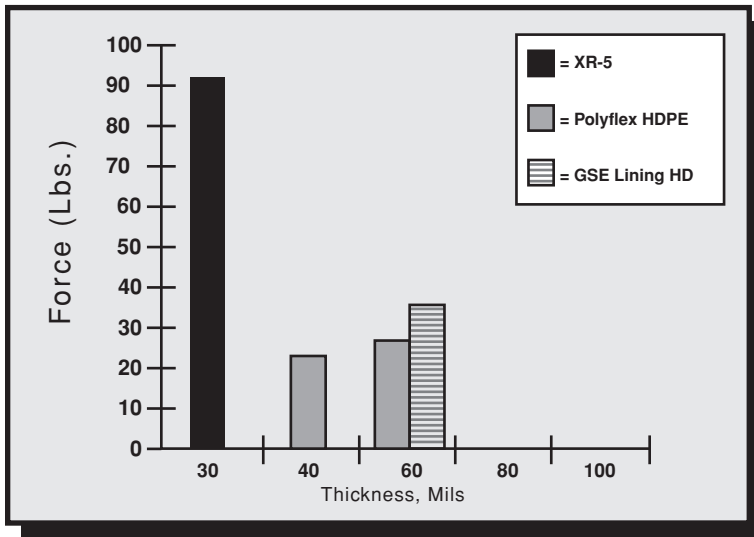

4. FED-STD-101C Method 2065 (100°C)\*

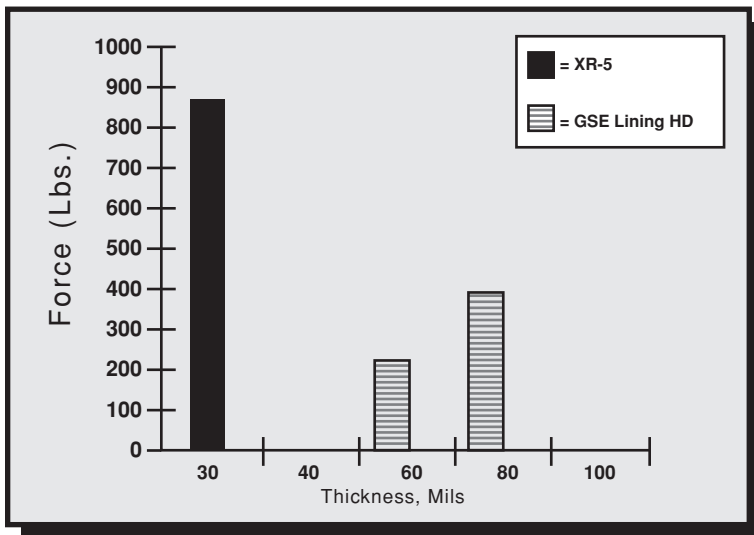

5. ASTM D 751 Ball Burst Puncture

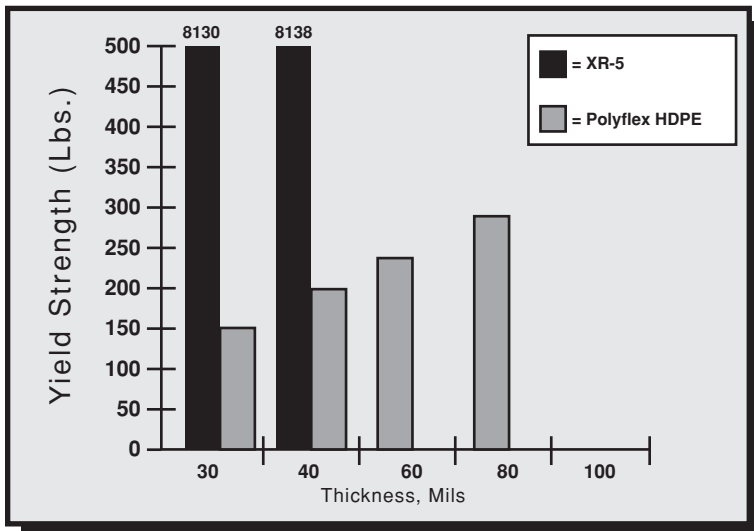

## Yield Strength

1. Yield Strength, XR-5 vs. HDPE

Test Method: Grab Tensile, ASTM D 751, 70° C

\* Data provided by E.I. DuPont de Nemours & Co. Wilmington, Delaware

GSE is a registered trademark of GSE Lining Technology, Inc.

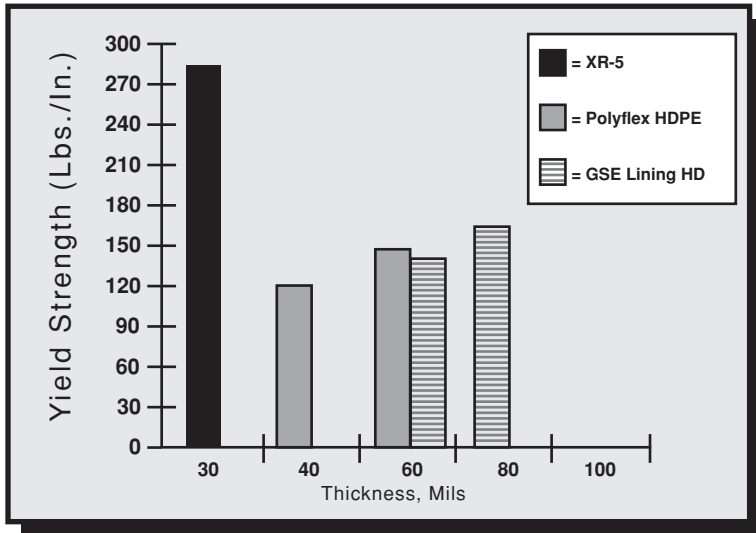

2. Strip Tensile, ASTM D 751, Room Temperature\*

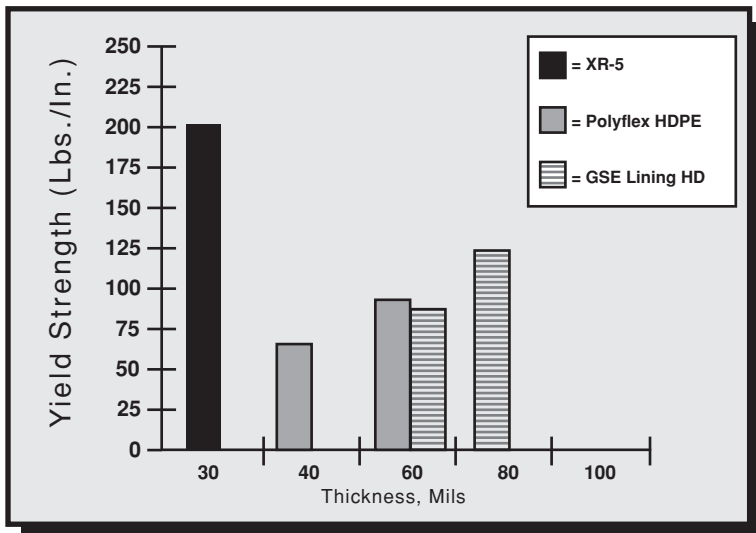

3. Strip tensile, ASTM D 751, 70°C\*

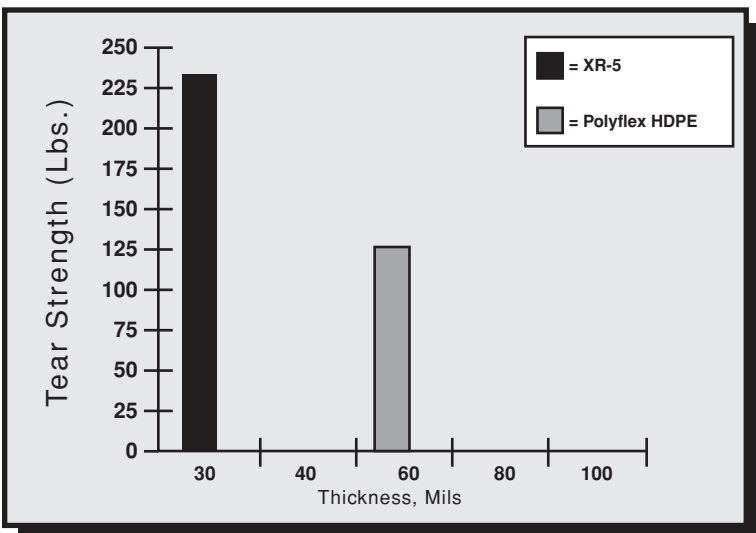

## Tear Strength

1. Tongue Tear (8" x 10" Specimens), ASTM D 751, Room Temperature\*

\* Data provided by E.I. DuPont de Nemours & Co. Wilmington, Delaware

GSE is a registered trademark of GSE Lining Technology, Inc.

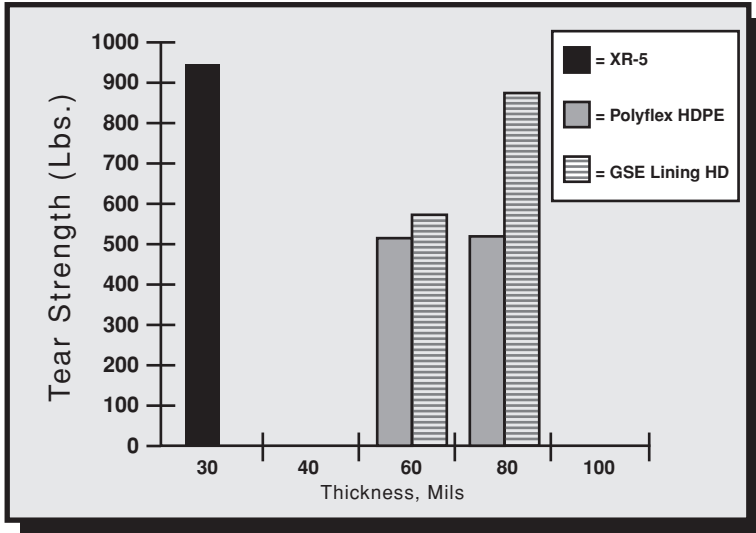

1. Graves Tear, ASTM D 624, Die C, Room Temperature\*

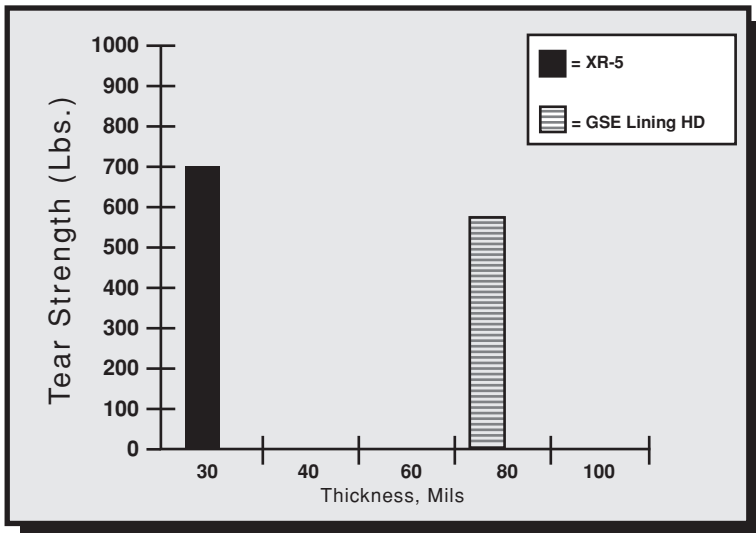

2. Graves Tear, ASTM D 624, Die C, 70°C\*

\* Data provided by E.I. DuPont de Nemours & Co. Wilmington, Delaware

GSE is a registered trademark of GSE Lining Technology, Inc.

## Grab Strength – XR-5® vs. Polypropylene Tensile

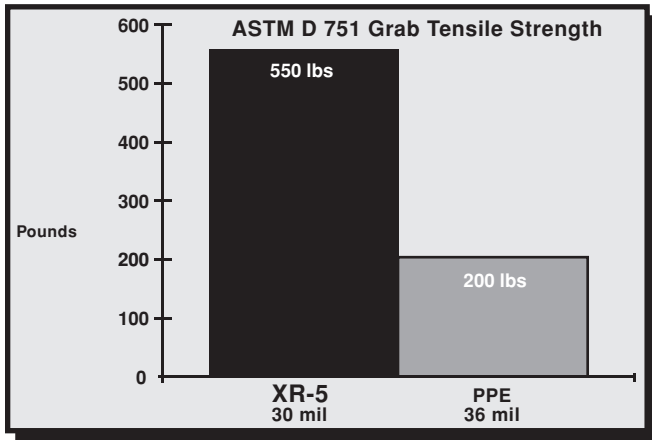

## Puncture Strength Comparison

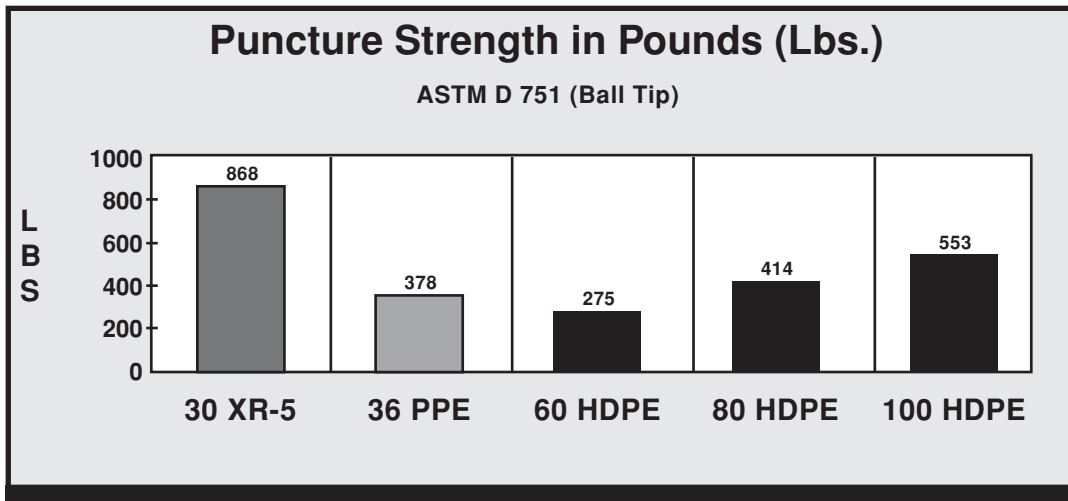

## Coated Fabric Thermal Stability

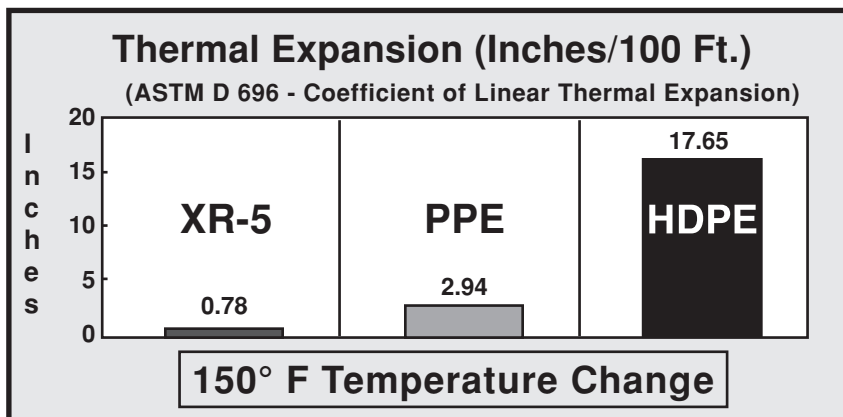

# Specification For Geomembrane Liner

(Sample specification: 8130 XR-5®. For other product specifications, go to [www.xr-5.com](http://www.xr-5.com))

## General

### 1.01 Scope Of Work

Furnish and install flexible membrane lining in the areas shown on the drawings. All work shall be done in strict accordance with the project drawings, these specifications and membrane lining fabricator's approved shop drawings.

Geomembrane panels will be supplied sufficient to cover all areas, including appurtenances, as required in the project, and shown on the drawings. The fabricator/installer of the liner shall allow for shrinkage and wrinkling of the field panels.

### 1.02 Products

The lining material shall be 8130 XR-5 as manufactured by Seaman Corporation (1000 Venture Boulevard, Wooster, OH 44691; 330-262-1111), with the following physical specifications:

Base- (Type) .....	Polyester
Fabric Weight (ASTM D 751) .....	.6.5 oz./sq. yd.
Finished Coated Weight (ASTM D 751) .....	.30 ± 2 oz./sq. yd.
Trapezoid Tear (ASTM D 751) .....	.40/55 lbs. min.
Grab Yield Tensile (ASTM D 751, Grab Method Procedure A) .....	.550/550 lbs. min.
Elongation @ Yield (%) .....	.20% min.
Adhesion- Heat Seam (ASTM D 751, Dielectric Weld) .....	.40 lbs./2in. weld min.
Adhesion- Ply (ASTM D 413, Type A) .....	.15 lbs./in. or film tearing bond
Hydrostatic Resistance (ASTM D 751, Method A) .....	.800 psi min.
Puncture Resistance (ASTM D 4833) .....	.275 lbs. min.
Bursting Strength (ASTM D 751 Ball Tip) .....	.750 lbs. min.
Dead Load (ASTM D 751) Room Temperature .....	.220 lbs. min.
(2" overlap seam, 4 hours) 160°F .....	.120 lbs. min.
Bonded Seam Strength .....	.575 lbs. min.
(ASTM D 751 Grab Test Method, Procedure A)	
Low Temperature (ASTM D 2136, 4 hours- 1/8" Mandrel) .....	.Pass @ -30°F
Weathering Resistance ASTM G 153 Carbon Arc .....	.8,000 hours min.
	With no appreciable changes or stiffening or cracking of coating
Dimensional Stability (ASTM D 1204, 212°F 1 Hour, Each Direction) .....	.0.5% max.
Water Absorption (ASTM D 471, 7 Days) .....	.0.025 kg/m <sup>2</sup> max. @ 70°F
	.0.14 kg/m <sup>2</sup> max. @ 212°F
Abrasion Resistance ASTM D 3389, .....	.2000 cycles before fabric exposure;
H-18 Wheel, 1000 g load .....	.50 mg/100 cycles max. wgt. Loss
Coefficient of Thermal Expansion/Contraction (ASTM D 696) .....	.8 x 10 <sup>-6</sup> in/in/° F max.

### 1.03 Submittals

The fabricator of panels used in this work shall prepare shop drawings with a proposed panel layout to cover the liner area shown in the project plans. Shop drawings shall indicate the direction of factory seams and shall show panel sizes consistent with the material quantity requirements of 1.01.

Details shall be included to show the termination of the panels at the perimeter of lined areas, the methods of sealing around penetrations, and methods of anchoring.

Placement of the lining shall not commence until the shop drawings and details have been approved by the owner, or his representative.

#### **1.04 Factory Fabrication**

The individual XR-5® liner widths shall be factory fabricated into large sheets custom designed for this project so as to minimize field seaming. The number of factory seams must exceed the number of field seams by a factor of at least 10.

A two-inch overlap seam done by heat or RF welding is recommended. The surface of the welded areas must be dry and clean. Pressure must be applied to the full width of the seam on the top and bottom surface while the welded area is still in a melt-type condition. The bottom welding surface must be flat to insure that the entire seam is welded properly. Enough heat shall be applied in the welding process that a visible bead is extruded from both edges being welded. The bead insures that the material is in a melt condition and a successful chemical bond between the two surfaces is accomplished.

Two-inch overlapped seams must withstand a minimum of 240 pounds per inch width dead load at 70° F. and 120 pounds per inch width at 160° F. as outlined in ASTM D 751. All seams must exceed 550 lbs. bonded seam strength per ASTM D 751 Bonded Seam Strength Grab Test Method, Procedure A.

#### **1.05 Inspection And Testing Of Factory Seams**

The fabricator shall monitor each linear foot of seam as it is produced. Upon discovery of any defective seam, the fabricator shall stop production of panels used in this work and shall repair the seam, and determine and rectify the cause of the defect prior to continuation of the seaming process.

The fabricator must provide a Quality Control procedure to the owner or his representative which details his method of visual inspection and periodic system checks to ensure leak-proof factory fabrication.

#### **1.06 Certification and Test Reports**

Prior to installation of the panels, the fabricator shall provide the owner, or his representative, with written certification that the factory seams were inspected in accordance with Section 1.05.

#### **1.07 Panel Packaging and Storage**

Factory fabricated panels shall be accordian-folded, or rolled, onto a sturdy wooden pallet designed to be moved by a forklift or similar equipment. Each factory fabricated panel shall be prominently and indelibly marked with the panel size. Panels shall be protected as necessary to prevent damage to the panel during shipment.

Panels which have been delivered to the project site shall be stored in a dry area.

#### **1.08 Qualifications of Suppliers**

The fabricator of the lining shall be experienced in the installation of flexible membrane lining, and shall provide the owner or his representative with a list of not less than five (5) projects and not less than 500,000 square feet of successfully installed XR-5 synthetic lining. The project list shall show the name, address, and telephone number of an appropriate party to contact in each case. The manufacturer of the sheet goods shall provide similar documentation with a 10 million square foot minimum, with at least 5 projects demonstrating 10+ years service life.

The installer shall provide similar documentation to that required by the fabricator.

#### **1.09 Subgrade Preparation By Others**

Lining installation shall not begin until a proper base has been prepared to accept the membrane lining. Base material shall be free from angular rocks, roots, grass and vegetation. Foreign materials and protrusions shall be removed, and all cracks and voids shall be filled and the surface made level, or uniformly sloping as indicated

on the drawings. The prepared surface shall be free from loose earth, rocks, rubble and other foreign matter. Generally, no rock or other object larger than USCS sand (SP) should remain on the subgrade in order to provide an adequate safety factor against puncture. Geotextiles may be used to compensate for irregular subgrades. The subgrade shall be uniformly compacted to ensure against settlement. The surface on which the lining is to be placed shall be maintained in a firm, clean, dry and smooth condition during lining installation.

#### **1.10 Lining Installation**

Prior to placement of the liner, the installer will indicate in writing to the owner or his representative that he believes the subgrade to be adequately prepared for the liner placement.

The lining shall be placed over the prepared surface in such a manner as to assure minimum handling. The sheets shall be of such lengths and widths and shall be placed in such a manner as to minimize field seaming.

In areas where wind is prevalent, lining installation should be started at the upwind side of the project and proceed downwind. The leading edge of the liner shall be secured at all times with sandbags or other means sufficient to hold it down during high winds.

Sandbags or rubber tires may be used as required to hold down the lining in position during installation. Materials, equipment or other items shall not be dragged across the surface of the liner, or be allowed to slide down slopes on the lining. All parties walking or working upon the lining material shall wear soft-sole shoes.

Lining sheets shall be closely fit and sealed around inlets, outlets and other projections through the lining. Lining to concrete seals shall be made with a mechanical anchor, or as shown on the drawings. All piping, structures and other projections through the lining shall be sealed with approved sealing methods.

#### **1.11 XR-5 Field Seaming**

All requirements of Section 1.04 and 1.05 apply. A visible bead should be extruded from the hot air welding process.

Field fabrication of lining material will not be allowed.

#### **1.12 Inspection**

All field seams will be tested using the Air Lance Method. A compressed air source will deliver 55 psi minimum to a 3/16 inch nozzle. The nozzle will be directed to the lip of the field seam in a near perpendicular direction to the length of the field seam. The nozzle will be held 4 inches maximum from the seam and travel at a rate not to exceed 40 feet per minute. Any loose flaps of 1/8" or greater will require a repair.

Alternatively all field seams should also be inspected utilizing the Vacuum Box Technique as described in Standard Practice for Geomembrane Seam Evaluation by Vacuum Chamber (ASTM D 5641-94 (2006)), using a 3 to 5 psi vacuum pressure. All leaks shall be repaired and tested.

All joints, on completion of work, shall be tightly bonded. Any lining surface showing injury due to scuffing, penetration by foreign objects, or distress from rough subgrade, shall as directed by the owner or his representative be replaced or covered, and sealed with an additional layer of lining of the proper size, in accordance with the patching procedure.

#### **1.13 Patching**

Any repairs to the lining shall be patched with the lining material. The patch material shall have rounded corners and shall extend a minimum of four inches (4") in each direction from the damaged area.

Seam repairs or seams which are questionable should be cap stripped with a 1" wide (min.) strip of the liner material. The requirements of Section 1.11 apply to this cap stripping.

#### **1.14 Warranty**

The lining material shall be warranted on a pro-rated basis for 10 years against both weathering and chemical compatibility in accordance with Seaman Corporation warranty for XR-5® Style 8130. A test immersion will be performed by the owner and the samples evaluated by the manufacturer. Workmanship of installation shall be warranted for one year on a 100% basis.

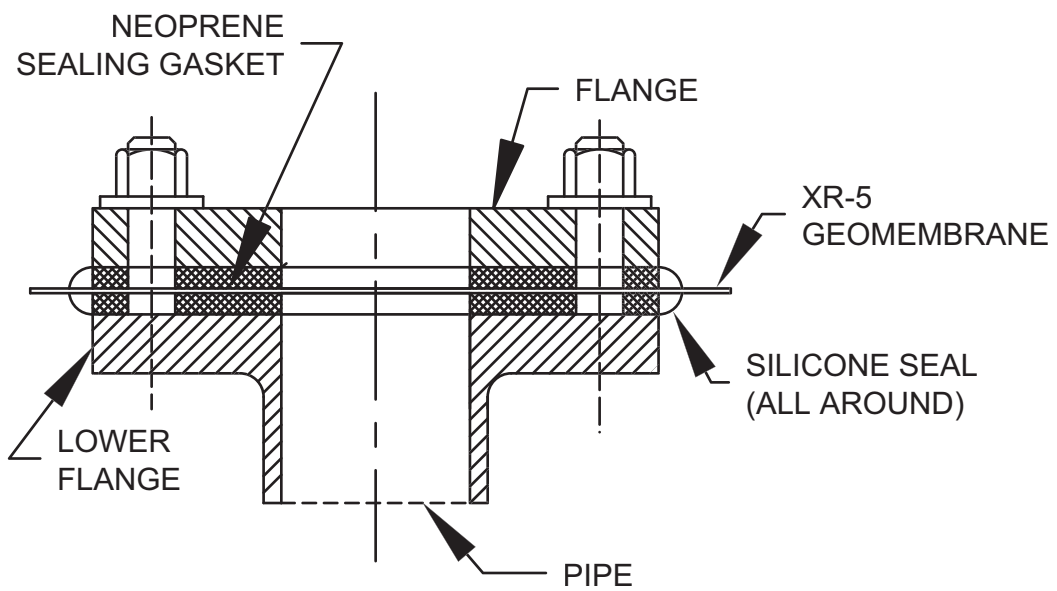

## Seaman Corporation

ENGINEERED PRODUCTS GROUP

1000 Venture Blvd., Wooster, Ohio 44691

### FLANGE CONNECTION TO PIPE SECTION

SCALE: NONE

SHEET 1 of 1

DRAW NO. XRD-019



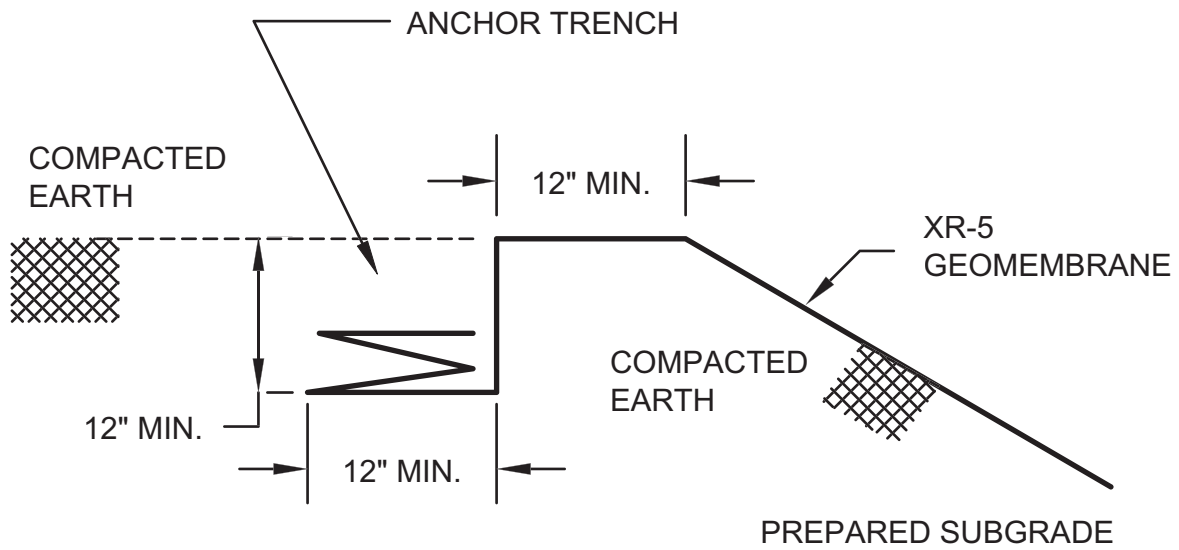

<p><b>Seaman Corporation</b>  ENGINEERED PRODUCTS GROUP  1000 Venture Blvd., Wooster, Ohio 44691</p>	
<p><i>ELEVATION VIEW  TYPICAL ANCHOR DETAILS  XR-5 LINER</i></p>	
<p>SCALE: NONE</p>	<p>DRAW NO. XRD-001</p>
<p>SHEET 1 of 1</p>	

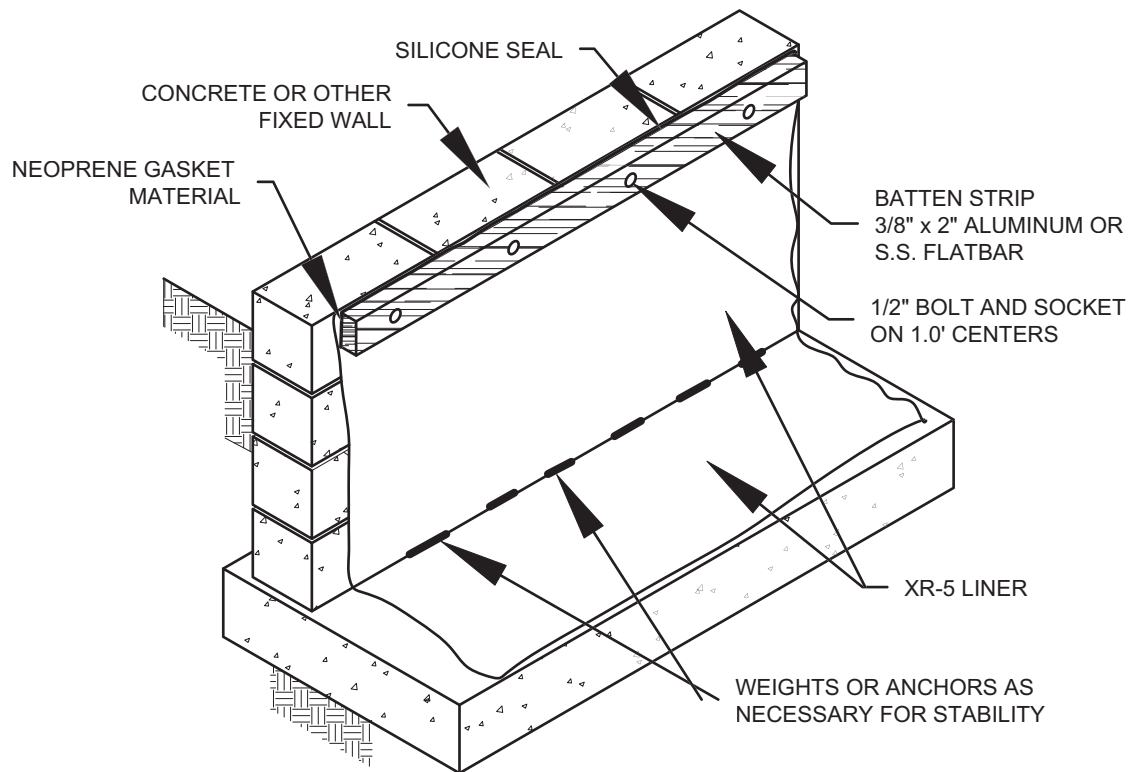

<p><b>Seaman Corporation</b>          ENGINEERED PRODUCTS GROUP          1000 Venture Blvd., Wooster, Ohio 44691</p>	
<p><i>ANCHORING DETAIL</i>  <i>XR-5 LINER TO FIXED WALL</i></p>	
<p>SCALE: NONE</p>	
<p>SHEET 1 of 1</p>	<p>DRAW NO. XRD-023</p>

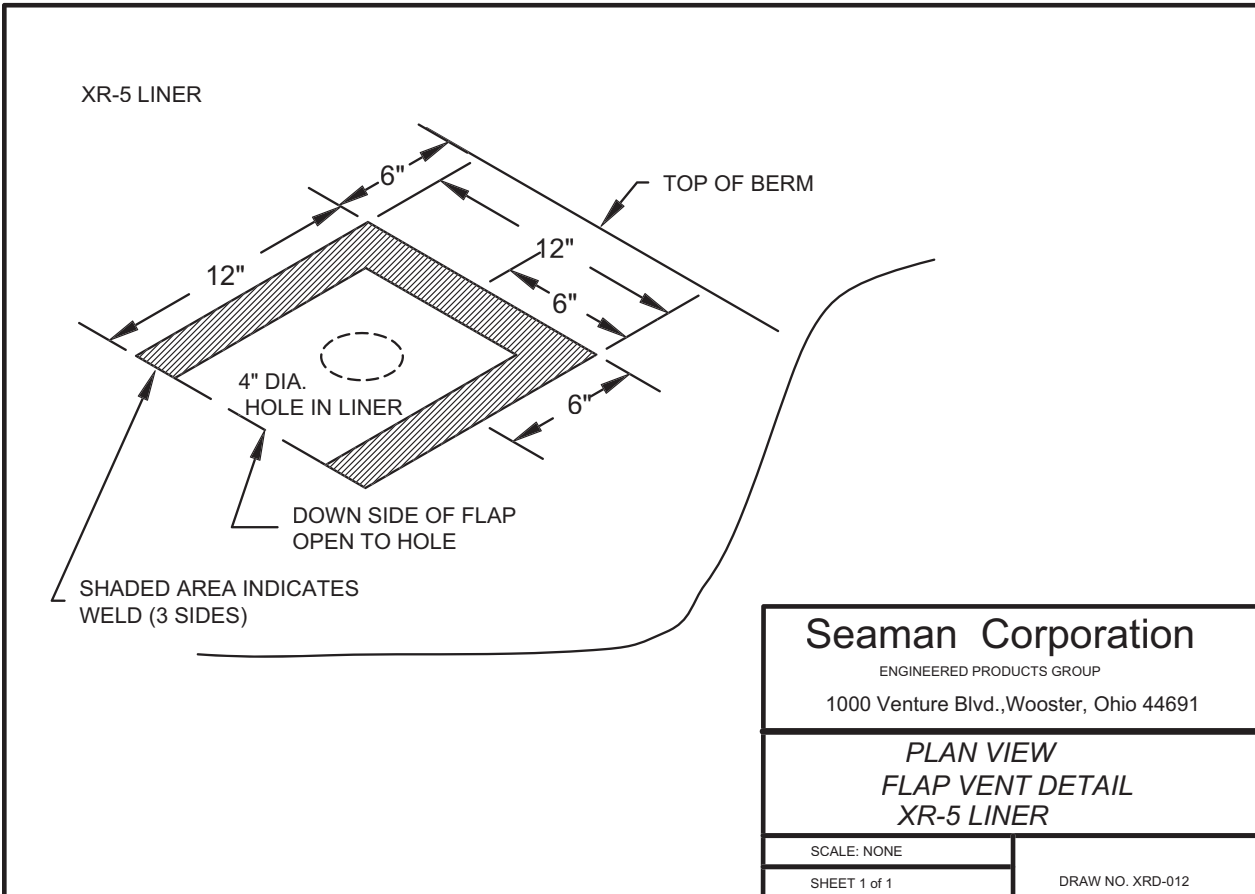
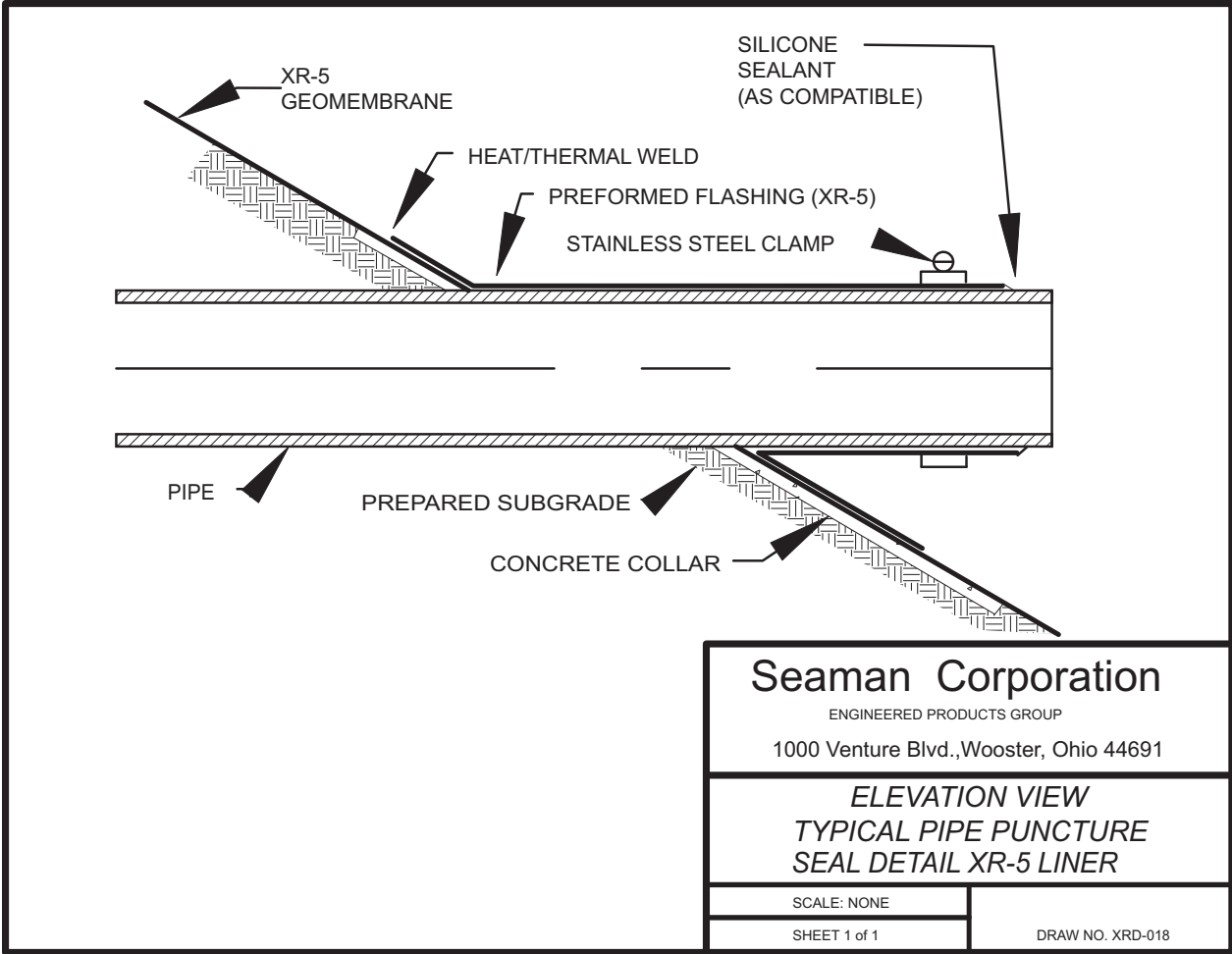

## Section 6 - Warranty Information

### Warranty

XR-5® is offered with Seaman Corporation standard warranty which addresses weathering and chemical compatibility for a 10-year period. A test immersion is required with subsequent testing and approval by Seaman Corporation.

#### Instructions for XR-5 Test Immersions and Warranty Requests

1. Completely immerse six Style 8130 XR-5 samples (8-1/2" x 11" size) in the liquid to be contained.
2. At the end of approximately thirty days, retrieve three of the samples. The samples should be rinsed with fresh water and dried.
3. Send the three samples to:  
Attn: Geomembrane Department  
Seaman Corporation  
1000 Venture Blvd.  
Wooster, OH 44691
4. Keep the other three samples immersed until further notice in case longer immersion data is required.
5. Complete and return the information form on the liner application.

8228 XR-3® and all PW Geomembranes are offered with a standard 10-year warranty for weathering. The attached information form should be completed.

# XR<sup>®</sup> Membrane Application and Utilization Form

**Installation Owner and Address:**

---

---

---

---

---

---

---

---

**Physical Location of Installation:**

---

---

---

---

---

---

---

---

**Expected Date of Installation:** \_\_\_\_\_

**Expected Beginning Date of Service:** \_\_\_\_\_

**Description of Application:**

(Example: impoundment used to contain brine on an emergency basis.)

---

---

---

---

---

---

---

---

**Physical Features of Application:**

(Example: 1.3 million gallon earthen impoundment with overall top dimensions of 160' x 160' with 3:1 slopes and 10' deep.)

---

---

---

---

---

---

---

---

**Description of Liquid:**

(Describe content of liquid including pollutants and expected temperature extremes in basin and at application point. Attach analysis of liquid chemistry, composition taken on a representative basis.)

---

---

---

---

---

---

---

---

**Operational Characteristics:**

(Describe the operation of the facility such as filling schedules, fluctuating liquid levels, operating temperatures, etc.)

---

---

---

---

---

---

---

---

**Performance Requirements, Etc:**

(State any other requirements, such as rate of permeability required.)

---

---

---

---

---

---

---

---

Owner represents the information herein is complete and accurate, and understands and agrees that issuance of Seaman Corporation Warranty for XR products are conditioned upon such completeness and accuracy.

\_\_\_\_\_  
OWNER'S SIGNATURE

**Reference Materials:**

---

---

---

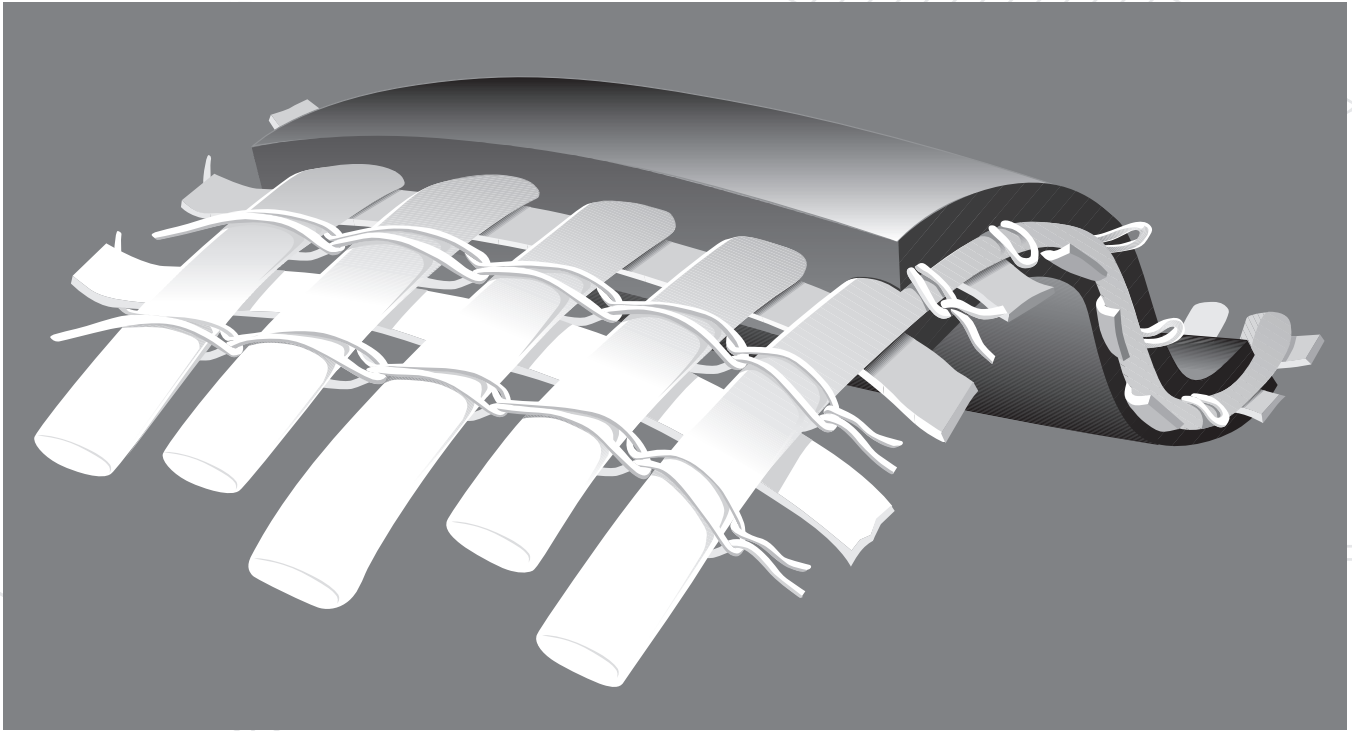

**XR-5®: High Performance Composite Geomembrane**



**Seaman Corporation**

1000 Venture Blvd.  
Wooster, Ohio 44691  
(330) 262-1111  
[www.xr-5.com](http://www.xr-5.com)